

Cognition and the Visual Arts

Robert L. Solso

A Bradford Book
The MIT Press
Cambridge, Massachusetts
London, England

Second printing, 1997
First MIT Press paperback edition, 1996

© 1994 Massachusetts Institute of Technology
All rights reserved. No part of this book may be reproduced in any form by any electronic or mechanical means (including photocopying, recording, or information storage and retrieval) without permission in writing from the publisher.

This book was set in Bembo by DEKR Corporation and was printed and bound in the United States of America.

Library of Congress Cataloging-in-Publication Data

Solso, Robert L., 1933–
Cognition and the visual arts / Robert L. Solso.
p. cm. — (MIT Press/Bradford Books series in cognitive psychology)
Includes bibliographical references and index.
ISBN 0-262-19346-9 (Hb), 0-262-69186-8 (Pb)
1. Visual perception. 2. Art—Psychology. 3. Cognition.
I. Title. II. Series.
BF241.S63 1994
701'.15—dc20

93-48658
CIP

7

A Truly Marvelous Feast: Visual Perspective



Oh, what a lovely thing is this perspective!

—Paolo Uccello

Long before humans used their eyes, brains, and muscles to guide complex sensory-motor actions, such as assembling a delicate watch or threading a tiny needle, our distant ancestors used the same instruments to hunt elusive antelopes, pick berries, avoid low-hanging branches, judge distances over an expansive plain, and remove small thorns from their feet. These were all matters of life and death. It was not enough to know *what* an object was (although it was important to know one's mate from a rock, eatable berries from poisonous ones, and so on). It was also important to know *where* it was. Much of the concern with the cognition of art has been directed toward visual localization and the perception of depth. How our ancient ancestors (and we) perform each of the common acts mentioned above is a difficult question requiring a complex answer. However, a large part of the problem deals with being able to see things “in depth.” The native propensity to see, to understand, and to guide one's behavior is contingent on the reciprocal action of the eye and brain as they differentiate near objects from distant objects—a topic called visual perspective, the theme of this chapter.

Seeing a 3-D World with a 2-D Eye

The world has three physical dimensions—height, width, and depth—plus the dimension of time. Visual signals from the physical dimensions enter the eye and are recorded on the retina, which has but two dimensions: height and width. We human animals are two-dimensional visual creatures seemingly trapped in a three-dimensional world by the geometry of the retina.

Nevertheless, the brain interprets two-dimensional visual images as having three dimensions by use of contextual cues and knowledge of the world as gained through a lifetime of experience. Thus, a three-dimensional world is recorded by a two-dimensional eye and then interpreted as three dimensions by the brain (the “3-D/2-D/3-D” problem). We may have a 2-D eye, but there is no doubt that we have a brain that sees in 3-D and beyond. These facts have baffled and bemused philosophers and scientists for centuries (see Berkeley for interesting philosophic considerations). Only within this century have scientists unraveled some of the mysteries surrounding the 3-D/2-D/3-D problem.

So compelling is the predisposition to “see” the world in 3-D that our eye and mind constantly decode flat stimuli as having depth. It seems that artists have, from the very beginning, known how the eye and brain use information to create the illusion of depth. One of the techniques used by artists is perspective—a method of representing a three-dimensional object on a two-dimensional surface, such as an artist’s canvas.

UCCELLO’S PERSPECTIVE: A WORKSHOP IN A DEVELOPING TECHNIQUE

Contemplate *The Battle of San Romano* by Paolo Uccello in figure 7.1. Uccello, who was obsessed with creating three-dimensional figures on a two-dimensional canvas, lures the viewer into this painting by a number of visual illusions, of which linear perspective is but one. Notice the use of larger figures in the foreground and smaller objects in the background, and how closer objects cover (occlude) distant objects. Careful inspection reveals two distinct scenes separated by a hedgerow: one, in the foreground, where soldiers are engaged in a battle, and another scene in the background in which bucolic characters romp seemingly oblivious to the riot. There is little attention to middle distances, and thus the background appears to be flat, as if only a backdrop to the central action taking place in the foreground.

Pay particular attention to the fallen warrior at the very bottom left of the painting (see detail). Here Uccello has used the technique of foreshortening (illustrating an object shorter than it is to create a three-dimensional illusion). It looks, more or less, natural—the way our eyes might see a recumbent figure.

The fallen warrior is important for another reason. Many of the salient figures in the foreground are generally oriented toward one central point, which is an important feature of linear perspective. The fallen soldier is



7.1 Paolo Uccello, *The Battle of San Romano* (National Gallery, London), with detail.

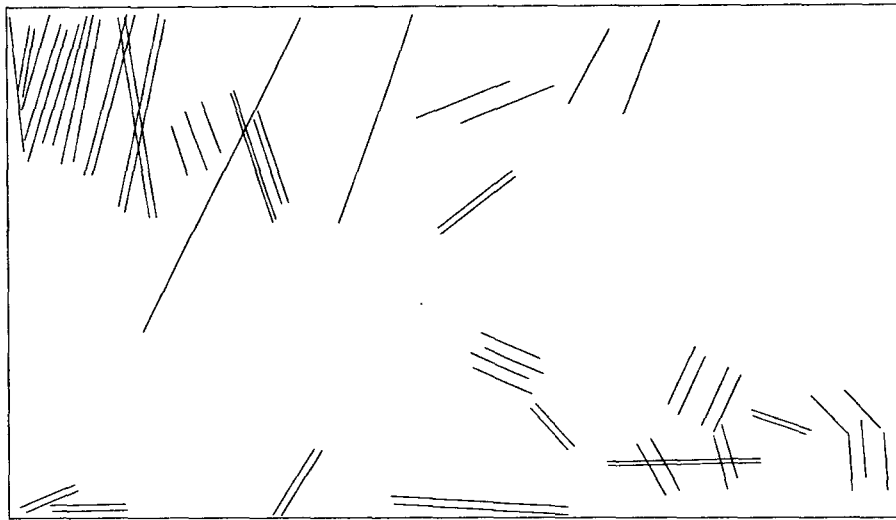

7.2 Parallel forces in *The Battle of San Romano*.

aligned with other strong visual cues, for example the lances that are parallel to the body (see figure 7.2). From our discussion in chapter 4 of Gestalt psychology, we learned that the mind's eye organizes these prominent features on the basis of similarity. The overall effect of similarly aligned features is to create an unconscious sensation that the entire scene is oriented toward an imaginary single point of reference. The eye organizes the real world by finding similar lines, which are interpreted as depth cues. So, too, does the eye achieve a sense of depth in this picture.

Uccello, as well as other Renaissance painters, employed other visual techniques to create an impression of depth. These include making distant objects smaller and higher than near objects, covering background objects with near objects, and making objects in the background seem less distinct than foreground objects. While one can see clearly the details of the bridle on the center horse, the features in the background are obscure. In addition, the artist has used bold contours in the foreground, fuzzy contours in the background; warm colors (reds and yellows) in the foreground, which seem to advance, and cool colors (blues and greens) in the background, which seem to recede. While it is clear that Uccello didn't get it just right (the men in the background would be the size of Goliaths if they appeared in the foreground at the same scale), this early attempt to use several perspective techniques does, nevertheless, create a sense of depth.

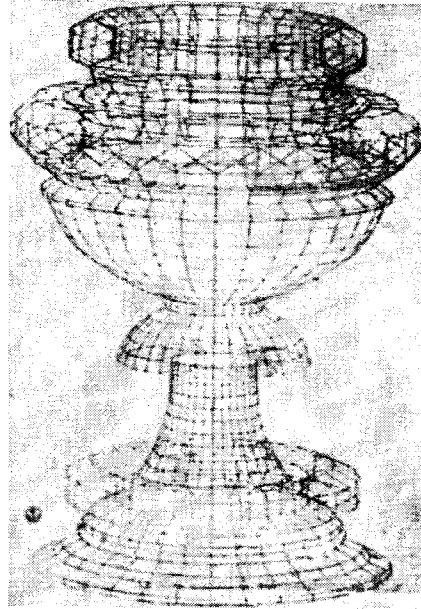

7.3 Chalice perspective: a study by Uccello.

Principles of Depth Perception: Where Is It?

Comprehension of physical objects is based on our knowledge of what the object is, what it is doing, and where it is. The initial process of visual identification of an object is based on its shape or contours, as we learned in our discussion of form perception (see chapters 3, 4, and 5). We know *where* an object is largely because of visual depth perception, which we will consider next. In a later section we will discuss the third question of what an object is doing (see the discussion of kinetic cues below). In everyday perception, from which we learn what the world is really like, all of these cues seem to be processed together, as if they were each a beautifully crafted musical instrument designed to play its part well but always attuned to the other instruments.

BINOCULAR AND MONOCULAR CUES

In recent years, perceptual psychologists have analyzed the types of perspective that have been used by artists to create a sense of depth. There are two general types of cues involved, binocular and monocular, and within each of these classes are several subclasses (figure 7.4).

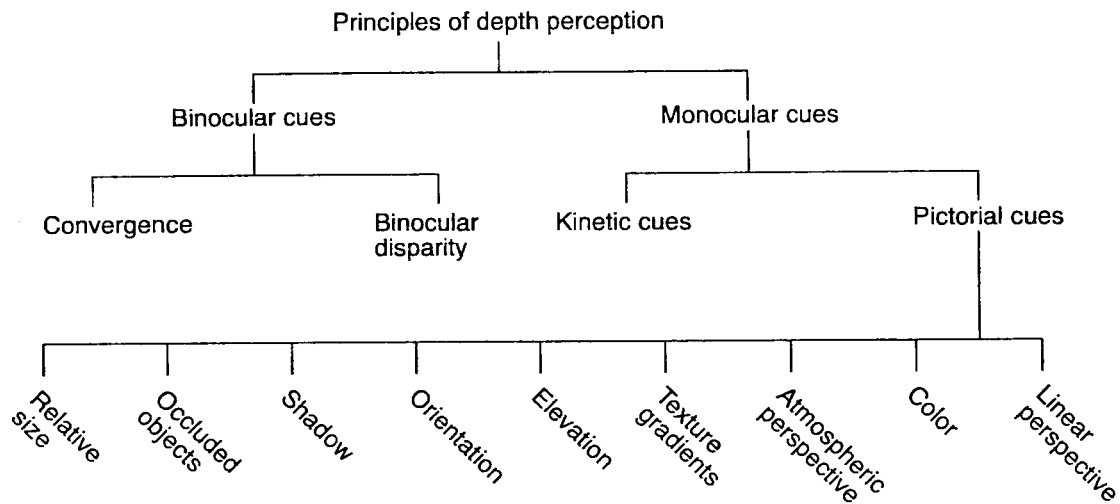

7.4 Classification of depth cues.

Binocular cues are those derived from the use of two eyes. Images that fall on one retina are not identical to the images that fall on the other, and information regarding this disparity is translated by the brain as a depth cue. Binocular perception of depth is particularly important in working with objects close to the eyes but, contrary to common opinion, is not critical for most forms of depth perception. People who, through accidents or disease, are left with only one good eye drive cars, play baseball (several major league players have been blind in one eye), and “see” most forms of art very much like you do. Furthermore, people with only one good eye from birth also have a good sense of depth. However, close work requiring depth perception is markedly impaired with single-eye vision. Try this little experiment. Remove and replace the lead in a mechanical pencil. (Do not use any other aids, such as steadying your hands by touching them.) Now close one eye and try to do this. (Threading a needle will produce the same effect.)¹ Chances are you had difficulty doing fine work with only one eye.

The ability to perform this simple hand-eye coordinated act is based, in part, on binocular disparity (sometimes called binocular parallax), in which the image that falls on one eye is (slightly) displaced on the other eye, and on convergence, the action of the ocular muscles as they move the eyes while focusing on an object. In figure 7.5 we can see how the pencil and lead fall on different parts of each retina. Furthermore, the disparity between eyes is shown in the differences between distances (represented by the line segments

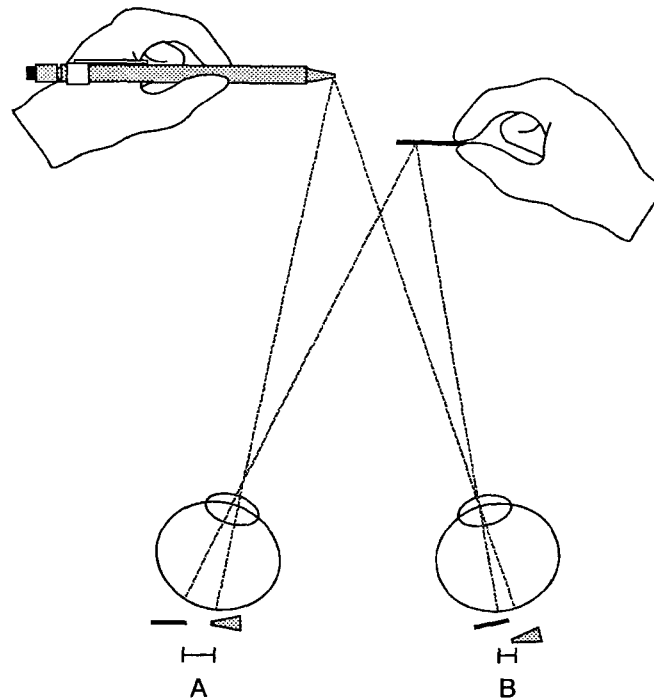

7.5 Area subtended by objects in left eye (A) and in right eye (B).

over A and B). These differences (for close objects), although small in actual span on the retina, are powerful depth cues for the brain. By the laws of simple geometry, we can easily see that more distant objects subtend visual space of very nearly identical size on each retina (the retinal disparity becomes less disparate) and thus the effect largely disappears. The science of binocular vision is important in perceptual psychology and in seeing some modern forms of op art, but for the most part the viewing of traditional two-dimensional art is more reliant on monocular cues.

Monocular cues are those that require only one eye, though they normally also involve both eyes (despite the name). Among monocular cues are visual stimuli available from the inspection of a stationary visual scene, such as the scene represented by an artist on canvas. Sometimes the term *pictorial* cues is applied to this type of scene, in distinction from another class of monocular cues that are based on motion. Movement cues, called *kinetic* cues, work when either the observer or the scene is in motion. Thus, when I look out my window and hold my head still, I know that the tree in the foreground is closer to me than the river, or the park, or the distant snow-capped mountains because of the pictorial cues available. If I move my head from

Perceived Distances and Familiarity

Given the perception that these five faces range from close to far, which face is at the same distance as the ball? The answer depends on how large the ball is. Suppose the ball is a basketball. Which face is on the same plane? Now suppose the ball is a Ping-Pong ball. Distance judgments are made on the basis of size as reflected on a person's retina (bottom-up processing) and on knowledge of the object (top-down processing).



7.6 Perceived distances and familiarity: an example of top-down and bottom-up processing of information.

side to side the relationships between near objects changes slightly. The tree in the foreground covers a part of the river and uncovers another part. Sometimes this monocular depth cue is called *motion parallax*, as motion provides the essential information on which depth perception is based. These cues to depth perception are essentially the same for one eye alone or two eyes functioning together and will be discussed later.

Monocular depth cues abound in art and everyday life. We learn, at a very young age, to use these cues to judge the relative location of objects. So powerful are these cues that it is possible to create an illusion of depth by presenting them on a two-dimensional surface. Psychologists have recently classified these cues, but for centuries artists have used the full range of monocular cues to indicate depth.

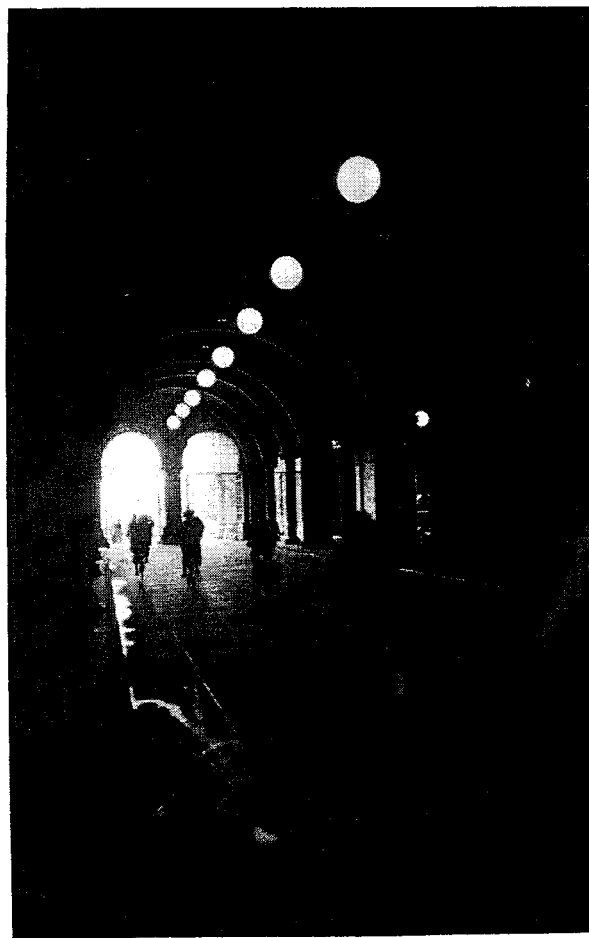
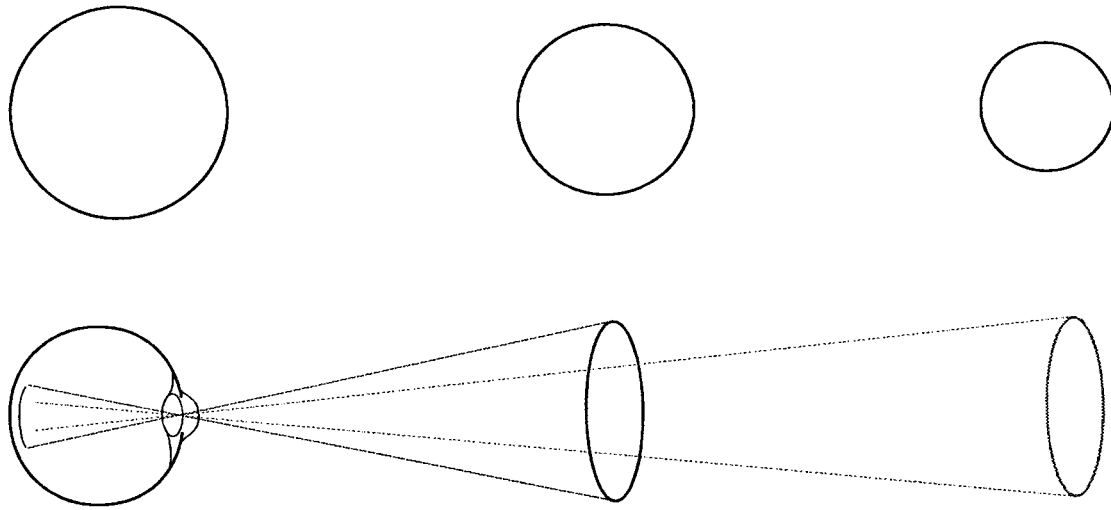

7.7 Which of the circles is most distant? In the lower drawing, the inverse relationship between object distance and retinal size is shown. (Compare the receding line of globes in the photo.)

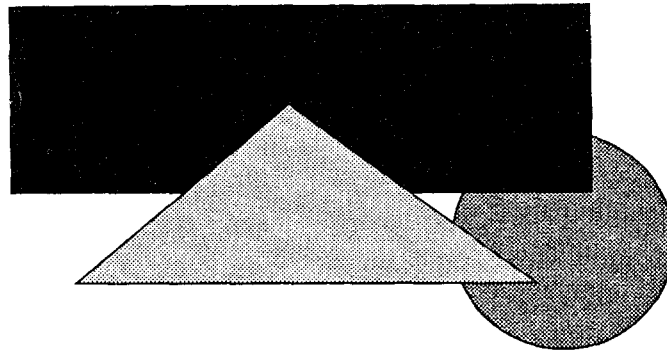

7.8 Which object is nearest? Farthest? Why?

RELATIVE SIZE

The size of the retinal image varies in inverse proportion to the distance of an object. Near objects appear larger than far objects because they occupy more space on the retina. In the perception of real world stimuli, an object 5 feet away casts an image on the retina twice the size as the same object viewed from 10 feet. Correspondingly, artists represent distances by the same geometric proportions, with near objects larger than distant ones. Relative size is a compelling depth cue, as shown by the drawing in figure 7.7. We immediately sense that these three circles may “in reality” be the same size, but located at three different distances. However, if you are told that the first circle is the size of a half-dollar, the second of a quarter, and the third of a dime, then the three circles appear to be of different size but located on the same plane. This feature of size is called *familiar* size and is based on our knowledge of the dimensions of well-known objects. In the parlance of an earlier discussion, these objects are processed in a top-down fashion.

OCCLUDED OBJECTS

Another type of depth perspective is obtained by the use of occluded objects (also known as interposition), in which foreground objects cover, or partly cover, distant objects. In figure 7.8 three geometric forms are shown all on the same plane, yet the impression is that the triangle is partly on top of the rectangle and circle and that the rectangle partly covers the circle. Hence, we infer that the triangle is the form closest to us, the circle the most distant. It

is possible, of course, that we have it all wrong. Perhaps the “circle” is not a circle at all, but a weirdly shaped form with slots and wedges cut out that coincide perfectly with the seemingly interposing rectangular and triangular forms. It is much more likely that we “see” a whole circle that is simply behind (and therefore more distant than) two other forms.

SHADOW

Depth can be ascertained by shadows, such as the way a shadow may be cast on the underside of a ball, which suggests a solid, three-dimensional object as contrasted with a flat two-dimensional object. The interpretation of these depth cues has proved to be a tricky and complex matter. Consider the disks in figure 7.9. Our mind and eye interpret these as being members of two classes, one class concave and the other convex. Those circles, or hemispheres, that “jump out” from the page are those that are light on the top and dark on the bottom. It seems our brain interprets these signals as if light were shining on a three-dimensional object from above. That makes sense. Most natural light appears from above. Therefore, a dark shadow on the underside (even if it’s the “underside” of a two-dimensional object) suggests to an observer that this is a three-dimensional object, something like half of a ball. If you rotate this figure 90 degrees, the illusion frequently disappears (although you can hold onto the image in that rotated orientation, and even

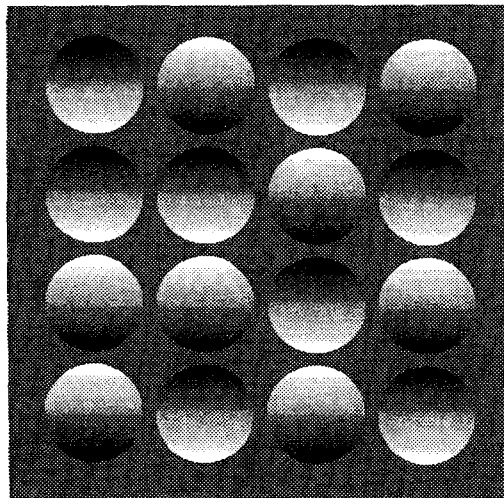

7.9 Depth cues supplied by shading. If the tops of the circles are light, they look like bumps. If the bottoms are light, they look like depressions. From Ramachandran (1988).

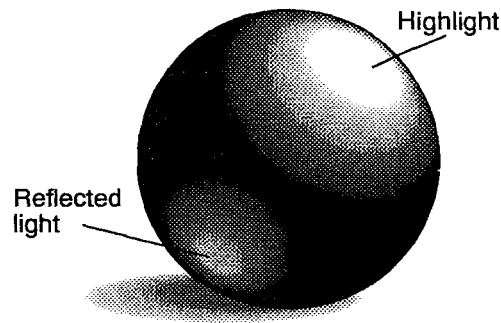

7.10 Light and shadow on a ball.

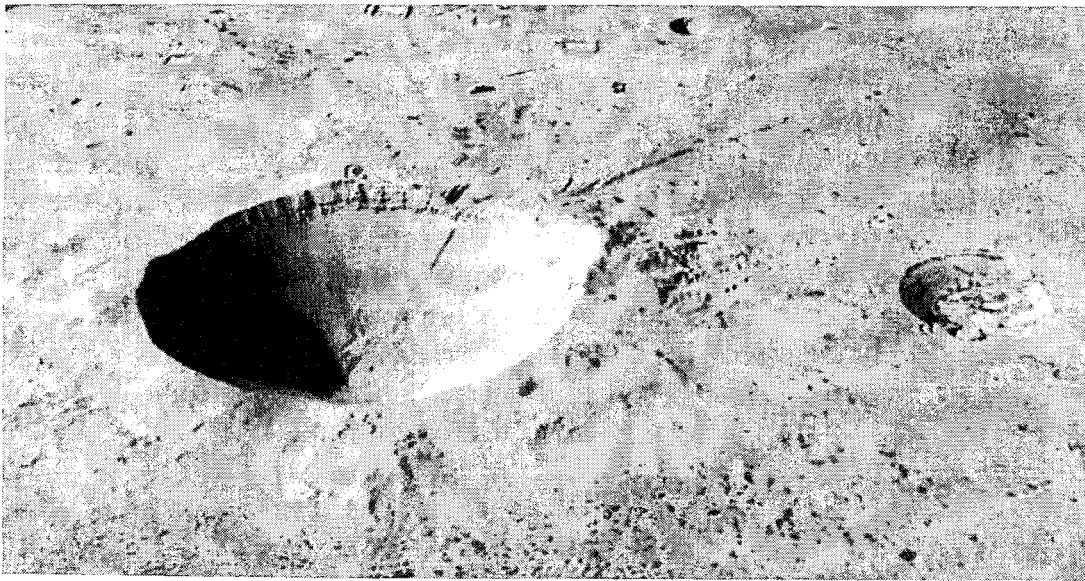

7.11 Shadow as a cue for depth. Turn the photo upside down and the crater becomes a hill.

beyond). If you continue to rotate the picture to 180 degrees, the formerly convex circles become concave and the formerly concave circles become convex! This object is fun to experiment with, and there are no prohibitions against twisting it every which way.

The illusion created by shadows is compelling. Take the rather pedestrian photograph shown in figure 7.11. Here the object looks like the crater that it is. However, if the picture is rotated 180 degrees, the crater suddenly becomes a mountain. This visual misinterpretation may seem quite benign, unless, of course you are navigating a space probe on some pock-marked

surface, like the moon. There, determining if an object is a mountain or a hole in the ground is likely to be critical.

When you view art, be aware of the powerful effects light and shadow have on our interpretation of scenes. Artists during the Renaissance and the impressionist period were sensitive to the effects shadows produced and used them skillfully.

ORIENTATION

Related to shadow effects, but decidedly different, is the effect that orientation, or the alignment of an object, has on depth perception. Many two-dimensional forms are seen as having three dimensions when viewed from one orientation, but only two when viewed from another. Consider the objects in figure 7.12. Most people see object A to be “flat” and describe it as “two diamonds hanging on a bar,” while object B appears to be a cube—a three-dimensional object. Yet if you rotate the page 45 degrees clockwise, you will see that the objects are identical except for orientation. This somewhat baffling phenomenon is largely ignored by perceptual psychologists and, as far as I can tell, has never been addressed seriously by artists. Yet the effect, as shown in this illustration, is compelling. I suspect the effect may have something to do with the strong vertical bar upon which the diamonds are hung. Another plausible cause is our familiarity with boxlike three-dimensional objects oriented at right angles to the ground. This effect is particularly forceful when accompanied with a verbal label (as your author has not so subtly supplied in this case). Thus, the effect of orientation seems to be largely due to top-down processing in which our eye and brain seek out images that remind us of something else we have seen. Since three-dimensional boxes are

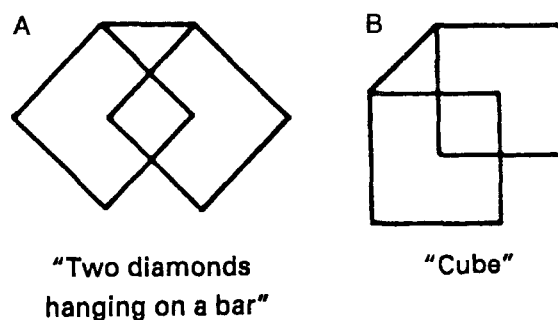

7.12 The effect of orientation on perception. Which of these objects appears to be a three-dimensional figure? From Solso (1991).

commonly seen, it is likely that we have a strong “box prototype” (see chapter 9 for a discussion of canonic forms). Thus, when we look at object B we interpret it in terms of the object in memory that it best approximates.

ELEVATION

By elevation I mean the relative vertical position of objects within a picture frame. Close objects appear toward the bottom of a painting, distant ones toward the top. Art simply reflects reality, in this case. Children represent distant objects by use of elevation without (it appears) any instruction. It is the way they see the world. It is the way they represent the world. From prehistoric to Egyptian to Asian to Renaissance to impressionist to (some) modern art, elevation has been used as an indication of depth, sometimes without regard to size or linear perspective. (See the discussion of Asian art below.)

TEXTURE GRADIENTS

A very robust set of pictorial cues that produce the sense of depth are those associated with texture. Consider the river stones shown in figure 7.13. The image that is projected on the retina is of a few “large” stones in the foreground, fanning out to numerous “small” stones in the background. The image shows a continuous change, a textural gradient, that depends on the spatial layout of the relevant surfaces; and we use this textural gradient as a cue for depth perception.

ATMOSPHERIC PERSPECTIVE

Another type of pictorial cue is based on atmospheric perspective, in which distant objects are represented as we might see them distorted in the physical world. Distant objects appear to be less precise, small details are lost, and colors become paler. The effect is caused by the way the atmosphere distorts objects. For example, colors shift in vividness and become softer, with a hint of blue tone. This effect is due to characteristics of the troposphere, or the air near the earth, which is filled with stuff. In Los Angeles, for example, the “stuff” is called “smog,” a mixture of smoke (or, more generally, hydrocarbon exhaust) and fog (or, more generally, water particles). This “stuff” distorts distant objects in a way most humans find obnoxious. There appears to be a

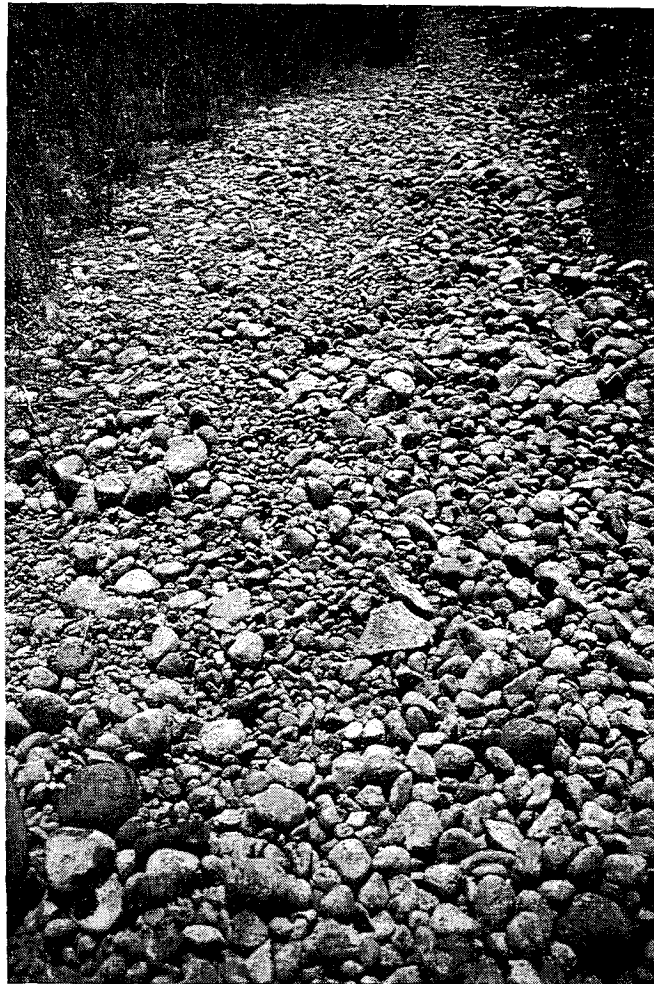

7.13 Stones in a river bed.

gunky pall over the city, and distant objects, rather than shifted toward the bluish end of the visual spectrum, are shifted to a kind of a dirty brown. In distant “clean” mountain regions, Lake Tahoe for example, distant objects are distorted but in a different way. Here water vapor in the air filters the light from distant objects, much as when we look through sunglasses, in a way that shifts the reflected light to the blue end of the spectrum (see figure 7.14). Different climatic conditions, regions of the world, and even times of day each have their own distinguishing

When painters of architectural scenes wish to show colors of things seen at a distance they employ veiling airs.

—Ptolemy
(2nd century A.D.)

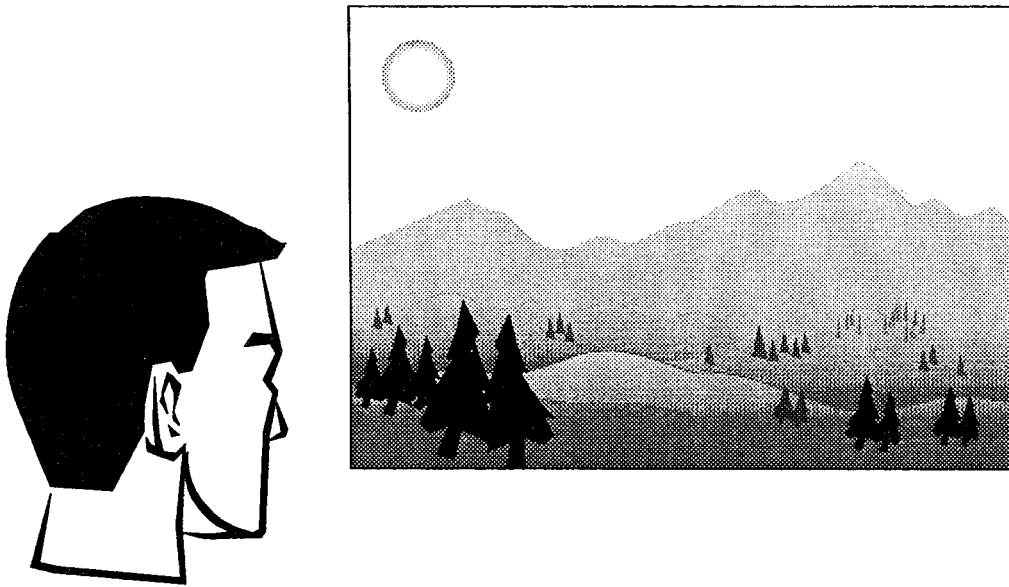

7.14 In atmospheric perspective, water particles and other substances in the atmosphere distort light reflected from distant objects. In the case illustrated here, shorter wavelengths are reflected back to the person's eye, which thus perceives the distant mountain to be a hazy, soft blue.

atmospheric “signatures,” which have been captured by landscape artists since Uccello and before. These cues, subtle as they may seem, tell the viewer much about a scene, depth information being but one of the several messages conveyed.

The artists of the Renaissance, neoclassicism, romanticism, and impressionism often used atmospheric perspective with much greater finesse than in the example by Uccello. Interestingly, during the later of these periods the strict use of linear perspective, which presents a rather stiff image, was eased, and a softer, more gracious effect was achieved without losing a sense of depth.

COLOR

In the real world of daily visual perception and processing of information, we experience the natural shift in colors of objects of varying closeness, and an object's color is an additional component of the process of knowing where the object is. In keeping with the effects of atmospheric perspective, warm colors seem to advance while cold colors recede. For example, an orange or

yellow object (warm colors) placed on a blue or green background (cold colors) seems to stand closer to the observer. This generalization is likely related to the way we see these colors in the real world, in which atmospheric distortion has a cooling effect on colors proportional to their distance from the viewer (largely due to the refracting effect of water vapor in the atmosphere).

In addition to this environmental reason, some theorists (e.g., Wright 1983) suggest a physical basis for colors acting as cues to depth, in that different colors come into focus at slightly different distances from our eye. To illustrate this, look at a color transparency, such as a common 35 mm slide. When viewed in a bright light (not projected), the reds seem to stand closer while the cool colors (e.g., blues) seem to stand farther away.

If in painting you wished to make one seem more distant than the other it is necessary to represent the air as a little hazy. . . . Paint the first building its true color; the next in distance make less sharp in outline and bluer; another which you wish to place an equal distance away, paint correspondingly bluer still; and one which you wish to show as five times more distant, make five times bluer.

—Leonardo da Vinci

LINEAR PERSPECTIVE

Of the many different techniques used to create visual perspective, linear perspective is mathematically most interesting. In linear perspective, the overall geometry of a painting suggests that its salient features converge on a single point, called the *vanishing point* (see figure 7.15), near the back center. We are so used to seeing these cues of visual perspective that artists incorporated them in their drawings. Uccello, who was one of the earliest of the Italian painters to experiment with perspective, did not calculate the precise linear coordinates in composing *The Battle of San Romano*; and hence we get the impression that something is not quite square with this painting. Later Italian painters, especially during the later Renaissance, became so obsessed with the geometric correctness of their compositions that many paintings look like architectural renderings.

KINETIC CUES: WHAT IS IT DOING?

The most ecologically powerful depth cue is movement. Along with other cues, it tells us what something is doing. Things close to our eyes seem to



7.15 Visual cues of depth showing a vanishing point.

dart by quickly, while distant things seem to move slower. Look at a high-flying jet as it slowly moves across the sky. Although its speed may approach 600 mph, because it is far from our eyes and therefore subtends a smaller visual angle it appears to move slowly. Now, consider a fast-moving automobile close to your eyes. The subjective experience is that the near object is moving much faster than the distant airplane.² The principle involved is called motion parallax and is one of the most powerful cues for three-dimensionality.

Motion parallax is missing in traditional art forms, although some very interesting experiments are being done with computer graphics that simulate many of the effects of motion parallax.³ Its absence in two-dimensional art is important for our consideration of perspective. As absorbing as painting is, and as correct from a perspective viewpoint, it never completely fools the eye.⁴ This failure has everything to do with motion parallax. All you have to do to break the mesmerizing effect of perfectly drawn pictures is move your head . . . oh, ever so slightly. (More distant paintings, such as ceilings painted in large churches, require somewhat greater motion.) On a two-dimensional

Motion Parallax in Milan

In everyday life we are frequently reminded of depth perception through motion parallax, in which the relative motion of near objects seems more rapid than that of distant objects. In figure 7.16, the figures near the observer are blurred with movement, while distant objects (even if moving) are not.



7.16 Motion parallax: people moving.

canvas, the relative position of near and far objects remains the same. In real life, relationships among visual objects change all the time due to our head/eye movements and movements of the objects themselves (see figure 7.16).

Depth perception, which is very important for creatures living in a three-dimensional world, is achieved in large part through kinetic cues. This is evident through the nearly continuous motion of our eyes, and, if that were not enough, our head swivels around with the slightest of excuses. I believe

these motions serve to tell us where we are and where things in our view are. Much has been written about the techniques used by artists (especially Renaissance artists) to create a three-dimensional illusion. But few scholars even mention what appears to me to be the most important depth cue *not* available to these artists, motion parallax. The importance of relative motion as a powerful depth cue is, however, central to perceptual theorists, such as J. J. Gibson (1950, 1979), who suggest that most of our knowledge of the three-dimensional structure of the world is derived from the way an impression moves across the retina during locomotion.

Digesting Perspective: Illusions and Constancy

Showing things as they really are requires an understanding of the trigonometry of linear perspective—the way that objects and images are distorted as a function of a person's point of view. The mathematical laws that describe linear perspective are reasonably straightforward and were known to Renaissance scholars. To illustrate the way the eye distorts reality, consider a simple object, such as a rectangular table top. If you view this object from a slightly elevated angle, the retinal sensation is foreshortened, which is to say that the visual impression is one in which the actual figure is compressed. While the signal from the eye to the brain indicates a compressed object, the mind does not for an instant believe the object is actually of that shape. Likewise, when we see a person approach us, we do not believe that he or she is growing larger. The evolution of the central nervous system and the eye produced cognitive machinery that comprehends a wide variety of sensory exemplars as belonging to a superordinate class of objects. All sorts of “distorted” rectangular objects are projected onto the retina, and the brain understands them as “rectangular objects.” As simple as this is, the deception proved to be difficult to practice for Renaissance artists, and is no less difficult today.

Artists such as Uccello used a type of linear perspective called *one-point* perspective, as all the lines (more or less) converge on a single vanishing point. We also saw an example of this method of representing depth in the photograph of globes (figure 7.7) and will see another in Roger Shepard's “two-sized” monsters (figure 7.20). Other forms of perspective are also commonly used by artists, including *two-point* perspective and sometimes *three-point* perspective. These forms use multiple vanishing points, as in the case of the “basic” box.

THE BASIC BOX

The most elementary three-dimensional object beginning artists draw is the cube or box. Almost everyone can draw a three-dimensional box, but if it is properly constructed the simple box has two vanishing points (imaginary points on which features drawn in perspective converge). In figure 7.17 the structural components of two-point perspective are shown using a box. Here all the salient features—the “horizontal” edges of the box—if extended focus on a vanishing point. We are compelled to view this two-dimensional drawing as having depth. This two-point perspective could become a three-point perspective view if the vertical lines of the box also converged.

Even if a box is degraded in some way, such as having some features missing as in figure 7.18A, our brain decodes the impression as having three dimensions. A very similar “cube” is shown in figure 7.18B, but with one small difference that immediately transforms the object into a two-dimensional form—a sort of assemblage of mixed Y’s. What changes were made in the bottom figure?⁵

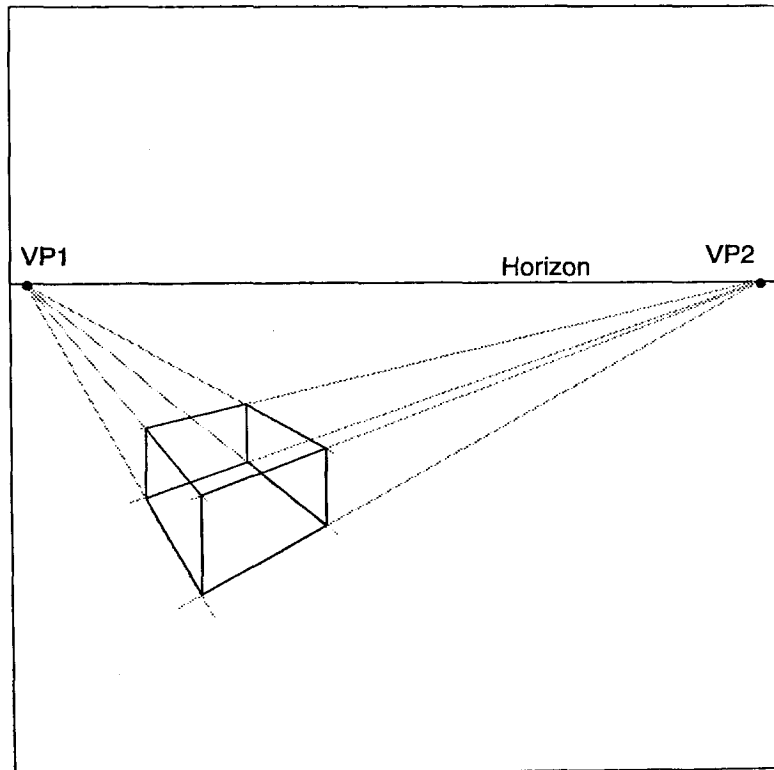

7.17 Vanishing points of a box.

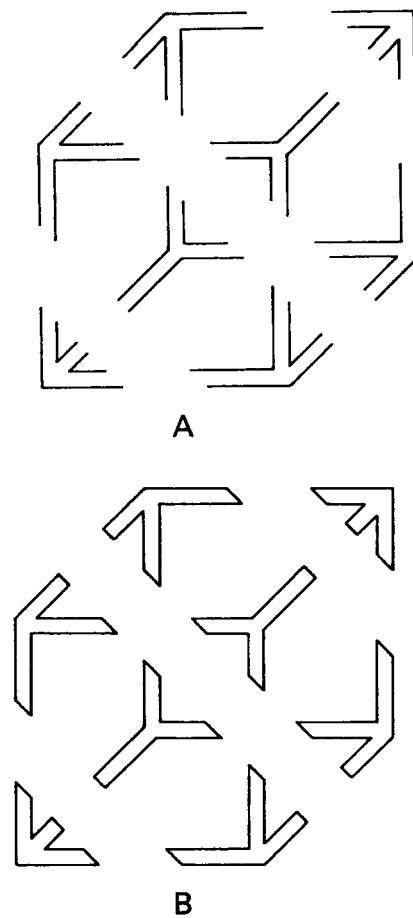

7.18 Cubes: three- and two-dimensional.

The cube and other rectangular shapes can be so compellingly organized as three-dimensional objects that artists frequently use them as models for all sorts of drawings, even those that use curved lines in their composition. (See figure 7.19.)

In these examples, one of the principles of linear perspective illustrated is that distant objects are diminished. Careful inspection of the farther edges of the cube in figure 7.17 reveals that they are smaller than the closer edges. In figure 7.20 we see two monsters, the smaller one being chased down a tunnel by the larger one. Look again. Which is really the larger? In fact, the two figures are the same size. Measure them. The illusion is compelling, even though we have empirical proof that the perception is but an illusion. We are led to this perception by the context of converging lines that make up the vault and floor of the tunnel. (One way to check illusions based on linear

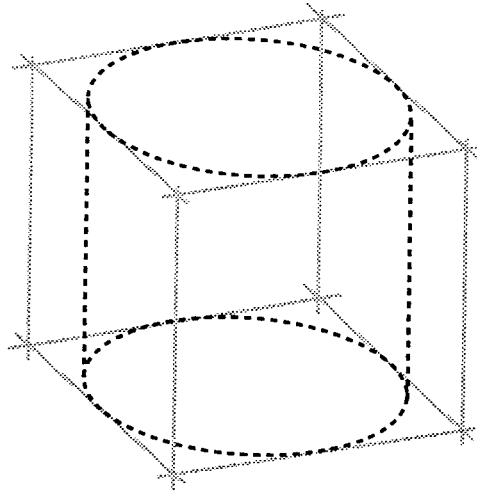

7.19 From a cube to a cylinder.

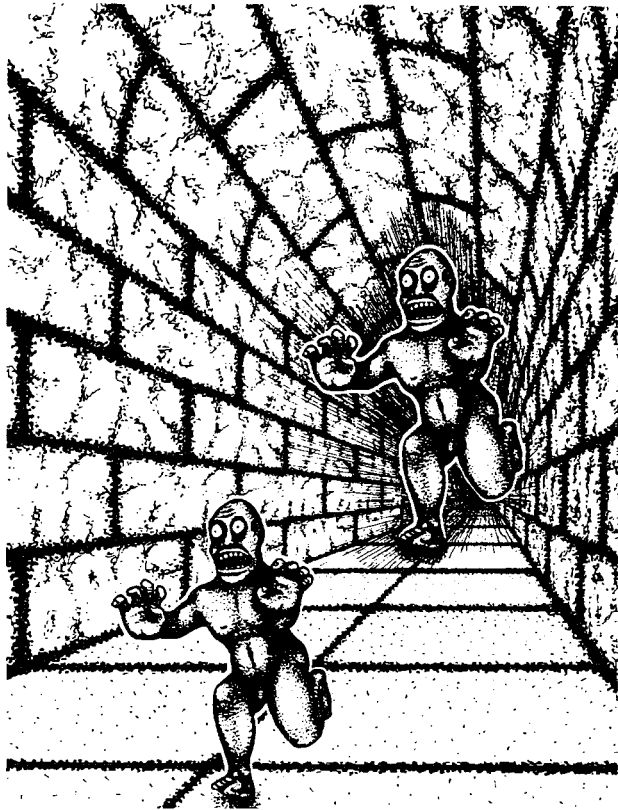

7.20 Which monster is larger? From Shepard (1990).

perspective is to make a cylinder, such as a rolled up sheet of paper, and view with one eye an object without visual context. Look at the head of one monster in figure 7.20 through a tube. Now look at the other monster's head. Take your "illusion buster" along when you visit a gallery. Act cool.)

Visual illusions that play on our strong tendency to use depth cues to judge the size of an object are not restricted to scenes having obvious diminishing points, as in the preceding example, but also apply to more subtle dimensions of geometric objects. In figure 7.21 we clearly perceive two tables, one long and narrow and the other short and fat. Yet, surprisingly, the shapes of the two table tops are identical in this figure. Measure them.

Many artists have used rectangular forms to create powerful depth cues. In figure 7.22 we see a sketch of how an artist might formulate his or her composition. Notice that the effects are drawn in relation to the eye level and to a vanishing point. One artist who has taken advantage of these cues in the modern artist Paul Klee, whose *Uncomposed Objects in Space* is shown in figure 7.23. By the use of numerous rectangles, all more or less drawn in perspective with a diminishing point, we are drawn in to the painting and convinced of its three-dimensional quality. It may well be that Klee is pointing out one of the basic paradoxes of 2-D humans functioning in a 3-D world: note the two-dimensional people in the lower right and lower center.

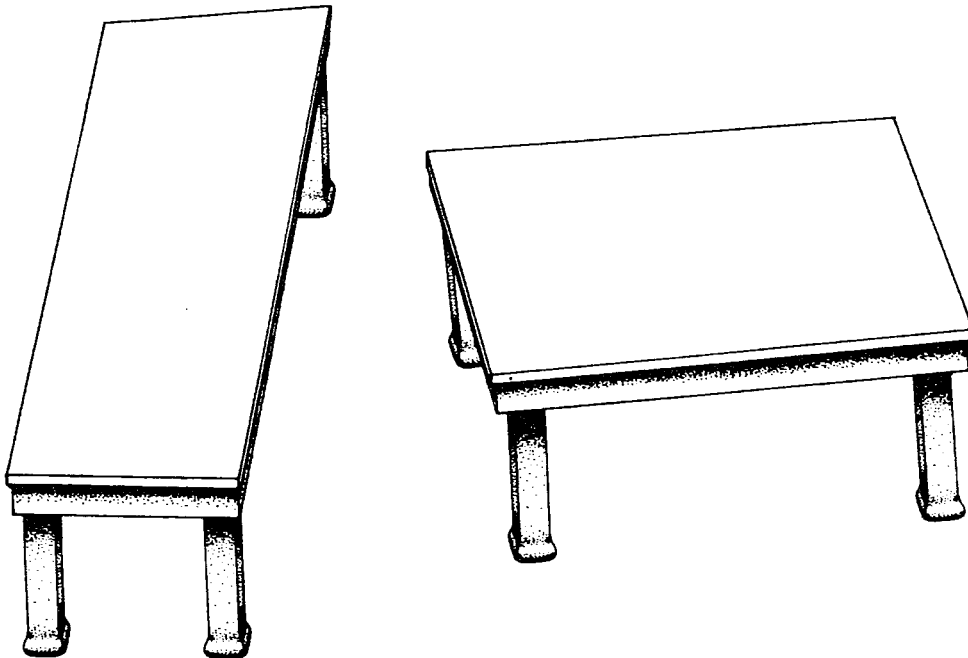

7.21 A tale of two tables. From Shepard (1990).

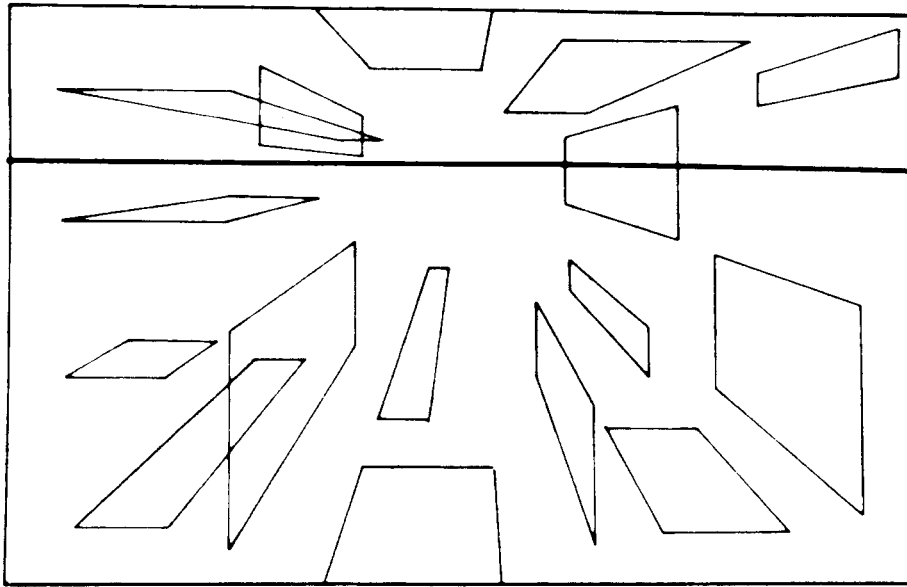

7.22 Artist's sketch of main compositional objects drawn in perspective. From Malins (1980).

RECUMBENT FIGURES: WHY THEY ARE SO HARD TO DRAW

Buildings and other geometrically regular forms are relatively easy to show in perspective, and artists since the early Renaissance have amazed their audiences with exquisitely drawn pictures of these objects. Painters sometimes created surprising visual effects by producing unusual angles of view, called *scorci*. Drawing figures in perspective, however, proved to be more challenging, and recumbent or unusually positioned figures were nearly impossible. This problem was faced by Uccello, whose fallen warrior was illustrated in figure 7.1. Undoubtedly Uccello struggled with this figure and drew a good approximation of how a fallen warrior would appear. In figure 7.24 we have redrawn the fallen man as an upright figure, given the best estimate of the overall perspective presented in the painting, with somewhat surprising results. As shown, the warrior is diminutive when standing up. Had a true perspective been used, the figure would be in scale with other upright people in the painting. Because we see people standing more often than we see them lying down, the problem of drawing a foreshortened recumbent figure is even more difficult. The artist, then, has two cognitive/perceptual problems to overcome: he or she must draw a reclining figure “in (geometric) perspec-

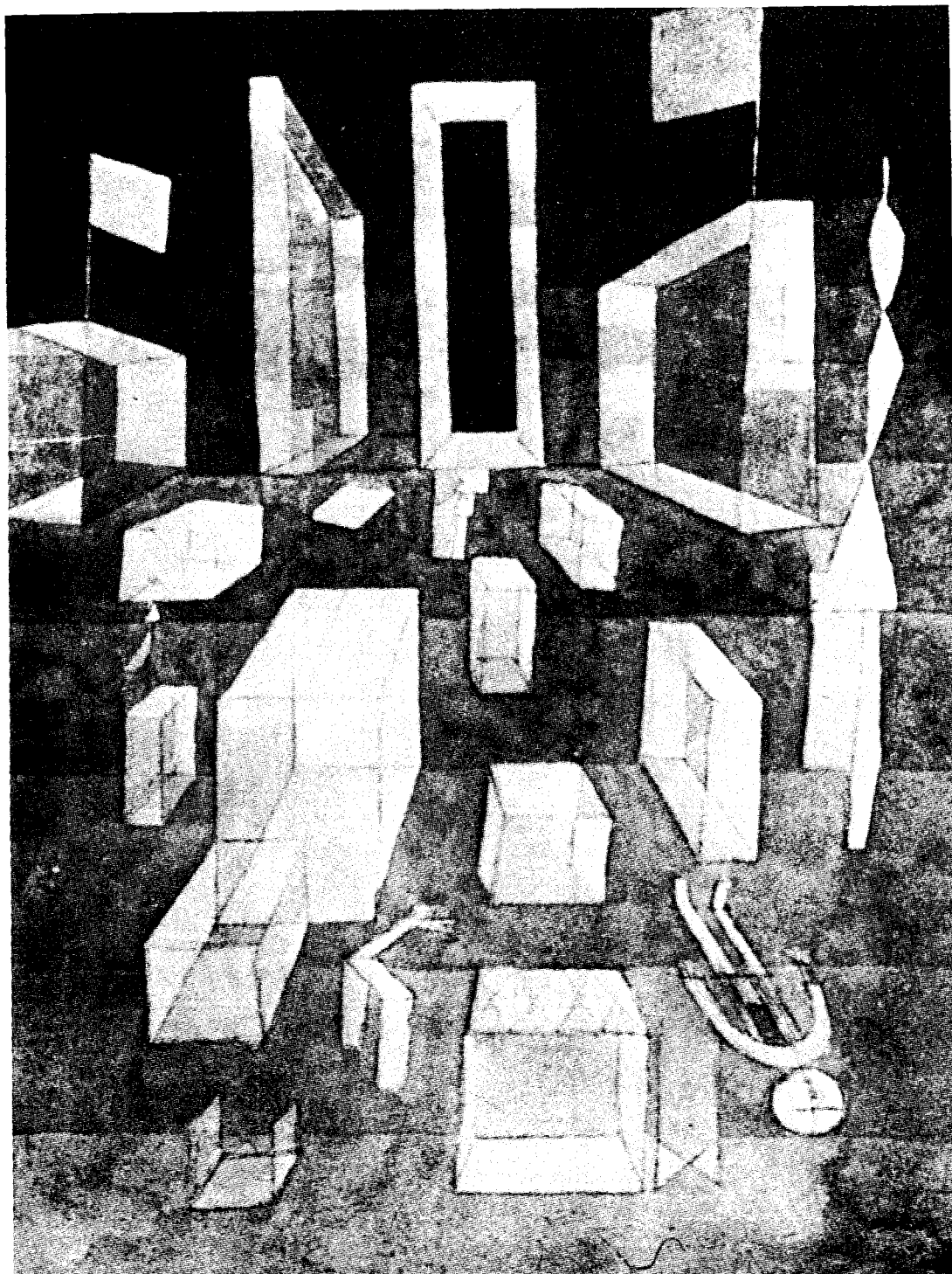

7.23 Paul Klee, *Uncomposed Objects in Space*.

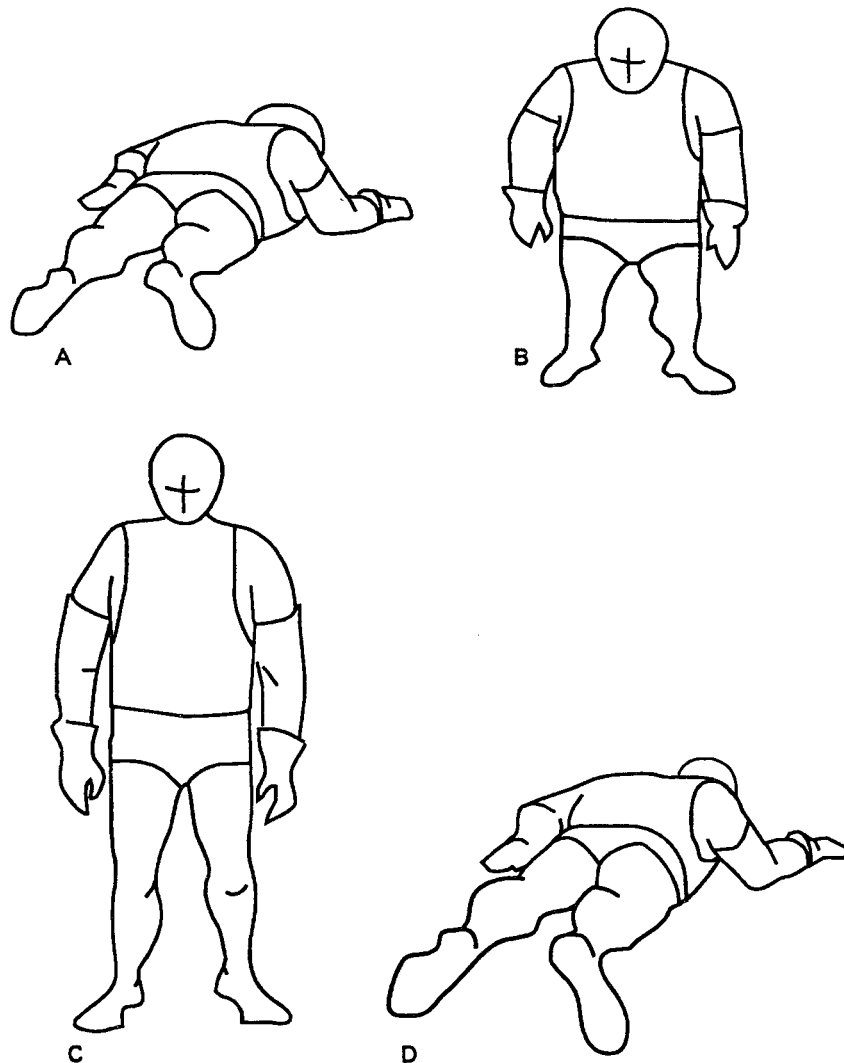

7.24 How Uccello's fallen warrior (A) would have looked standing up (B). How Uccello should have drawn the warrior using accurate perspective techniques (D). We have had this fellow stand up (C), and he is more realistic than Uccello's man.

tive" and must overcome the archetypal image of how people look when commonly perceived.

One means of drawing recumbent figures in perspective is to imagine (or even sketch) a "three-dimensional" rectangular frame in which principal body parts can be arranged (see figure 7.25). This technique was used in early teaching manuals for artists, as shown in figure 7.26. Here schematic heads ("block heads") are shown in such a way that the artist can see the geometric relationships between facial features from different orientations.

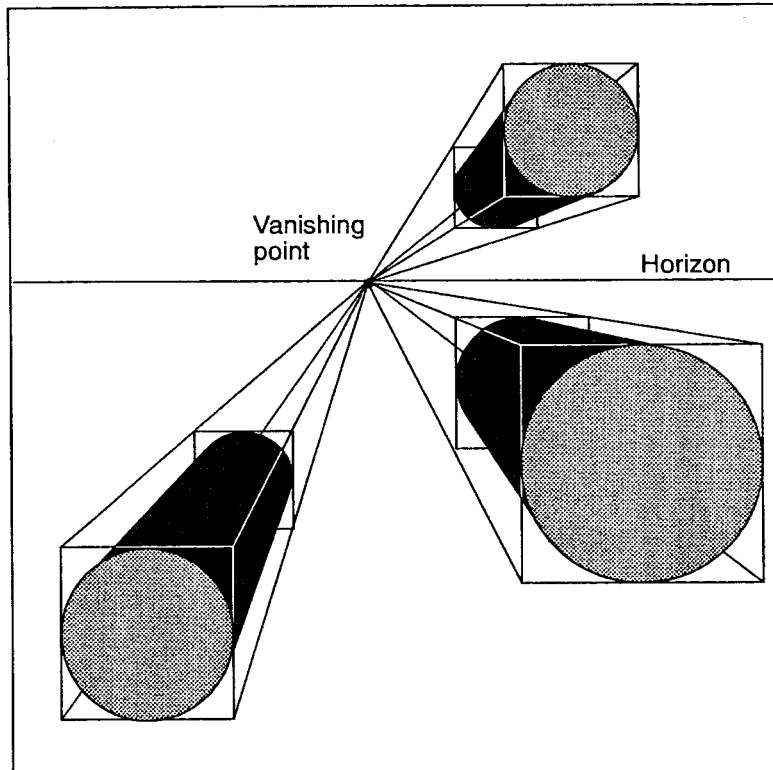

7.25 The use of three-dimensional rectangular and cylindrical forms to guide an artist in drawing objects in perspective.

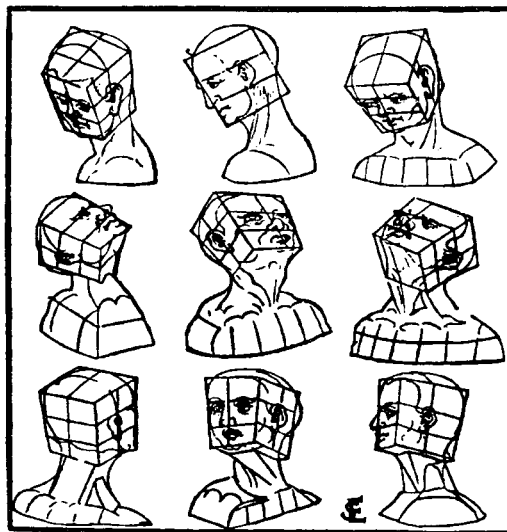

7.26 An early teaching manual for drawing heads. From Gombrich (1963).



7.27 Andrea Mantegna, *Dead Christ*, with added schematics. The use of cylinders to gain perspective is an artists' technique. Acute foreshortening problems can be overcome by superimposing cylinders or rectangles.

The use of this technique may be applied to the best-known example of extreme foreshortening, Mantegna's *Dead Christ* (see figure 7.27). The artist selected an unusual vantage point from which to portray the recumbent Christ. From this perspective all of the features of the body appear to be distorted. In figure 7.28 we see the original rendition (at bottom) and two copies made sometime later. These copies have altered the original perspective so that the Christ figure is more accurately shown. In spite of his intellectual appreciation of the mathematical laws of linear perspective, Mantegna's previous experience with recumbent figures and his respect for his subject persuaded him to use artistic license. Hence the facial features of the dead Christ are out of proportion to his feet. By violating the strict canons of linear perspective, Mantegna presented a far more powerful image of the dead Jesus, giving the viewer an intimacy and shocking proximity to the body, and especially to the face. Look at the reproduction at top right. The overall

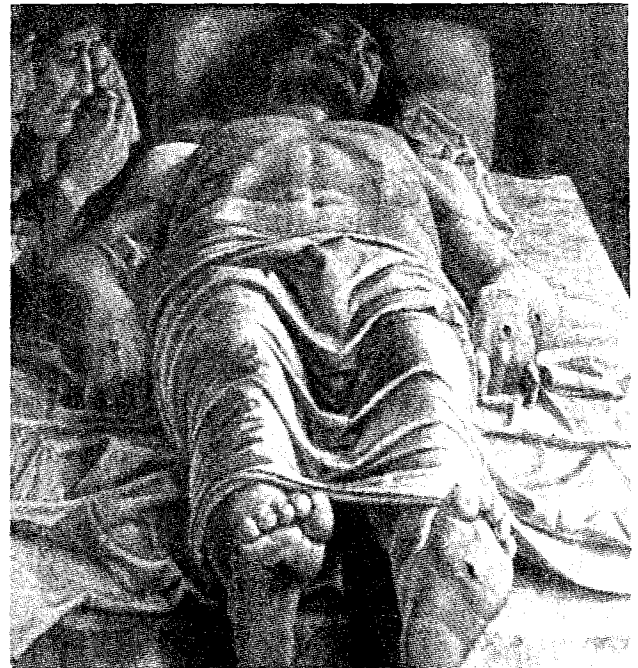

7.28 Mantegna's painting (bottom) and two later copyists' "corrected" versions. Note the relative size of the head in the three versions.

feeling one has from this rendering is of remoteness, distance, and aloofness, as contrasted with the almost voyeuristic image below.

These figures were hard to draw, not because the laws of linear perspective were unknown (they were not) nor because the artist lacked technical skill (he did not), but because our *perception* of the world is swayed by our concept of how things *should* appear. Lurking in the brain of all normal humans is a collective image or prototype of people, objects, things, ideas, and the like. We see the world through a thousand hypotheses. We see things that fit well within our preconceived notion of how things should appear, not necessarily as they actually do appear. The way we acquire the idea of “how things should appear” is one of the most fascinating chapters in the cognition of art. We have a pretty good idea of the psychological experiences that are the ingredients of prototype memories. Those exciting new discoveries are waiting for you in chapter 9. First we will conclude our discussion of perspective and art by tracing its history.

